

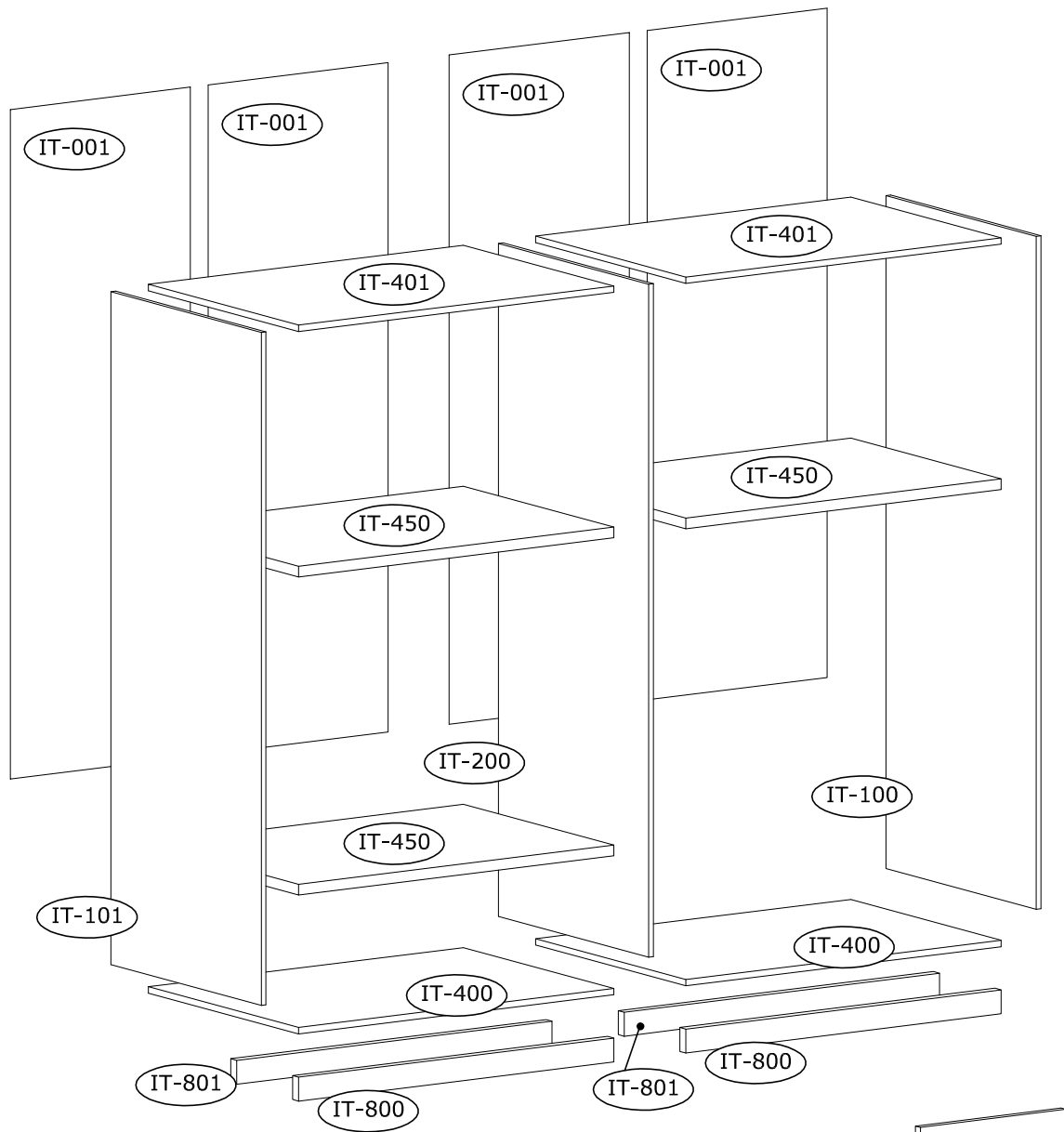

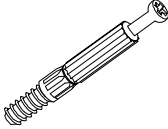

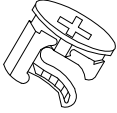

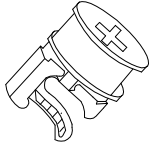
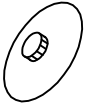
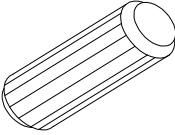

*Instrukcja montażu*  
*Montageanleitung*  
*Instructions D'assemblage*  
*Assembly instructions*  
*Návod na montáž*  
*Montážni návod*

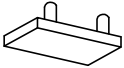

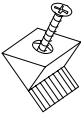
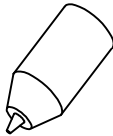
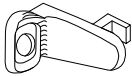
			
Ø6.5x36.5mm A-16	Ø15x16mm B-16	Ø15x22mm B2-12	Ø20 C-28
			
Ø8x30mm D-40	Ø14 D2-14	Ø3,5x13mm F-32	G-10
			
Ø4.0x25mm H-14	J-30	KL	M-8
			
Ø6.3x11mm N-8	S1-4	Ø3,0x13mm S2-4	T-6
			
2276mm Q-2	WV-16	L-872 DR1-2	

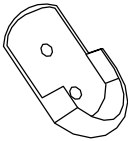

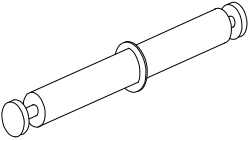
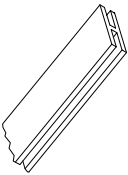
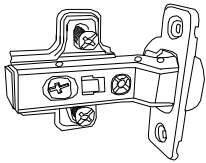
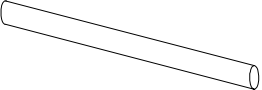
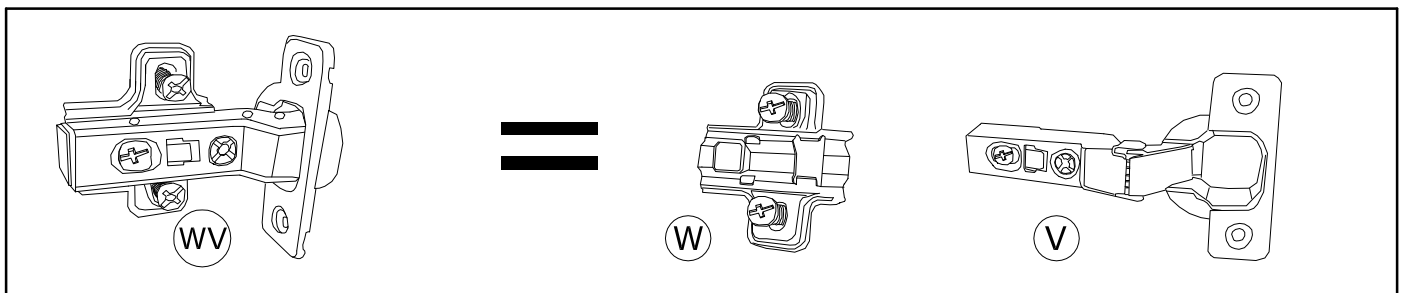
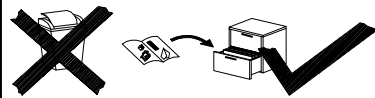
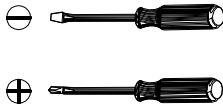
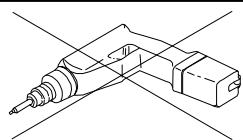

PL: WAŻNE INFORMACJE. Przed użyciem produktu należy dokładnie zapoznać się ze wskazówkami bezpieczeństwa. Należy zapoznać się z instrukcją obsługi i zachować ją do użytku w przyszłości.

GB: IMPORTANT INFORMATION! Please read the entire manual carefully before starting to assemble and/or using this product. Follow the manual thoroughly and keep it for further reference.

FR: INFORMATIONS IMPORTANTES Veuillez lire attentivement l'ensemble du manuel avant de commencer à monter et/ou utiliser ce produit. Suivez rigoureusement le manuel et conservez-le pour toute consultation ultérieure.

SK: DÔLEŽITÉ INFORMÁCIE! Predtým ako začnete s montážou a/alebo používaním tohto produktu si pozorne prečítajte celý návod. Návod dôsledne dodržiavajte a ponechajte si ho pre použitie v budúcnosti

CZ: DŮLEŽITÉ INFORMACE! Před sestavením nebo použitím výrobku si pečlivě přečtěte celý návod. Dodržujte důsledně uvedené pokyny a návod uschovejte, aby byl k dispozici v případě potřeby.

DE: MONTAGEANLEITUNG Bitte lesen Sie die Montageanleitung durch, bevor Sie mit dem Aufbau oder Benutzung beginnen. Folgen Sie den einzelnen Schritten der Anleitung und bewahren Sie auf.

PL: OSTRZEŻENIE PRZED WYWRÓCENIEM SIĘ MEBLA. Produkt musi być na stałe przymocowany do ściany dołączonymi uchwytnymi, aby uniknąć śmiertelnego wypadku, gdy się wywróci. W paczeczce są tylko śruby pozwalające na przykręcenie uchwytów do produktu, które zapobiegają przewróceniu się produktu. Prosimy o skontaktowanie się ze specjalistycznym sklepem lub fachowcem w sprawie śrub lub kołków, które należy zastosować do danego typu ściany.

GB: ANTI-TOPPLE WARNING! This product has to be permanently fixed to the wall with the bracket(s) included, to avoid fatal injury in case it topples over. The pack contains only screws for fastening the anti-topple bracket(s) itself to the product. Please contact your DIY or hardware store for advice on the correct type of screws/raw plugs for your type of wall.

FR: AVERTISSEMENT ANTIBASCULEMENT Ce produit doit être fixé de manière permanente au mur à l'aide du/des support(s) inclus afin d'éviter des blessures mortelles en cas de basculement. L'emballage contient des vis pour attacher le(s) support(s) antibasculement au produit. Veuillez contacter votre magasin de bricolage ou votre quincaillerie pour obtenir des conseils sur le type de vis/chevilles adapté à votre mur.

CZ: VAROVÁNÍ TYKAJÍCÍ SE SKLOPENÍ! Tento výrobek musí být trvale připevněn na stěnu pomocí přiložených držáků, aby nedošlo ke smrtelnému zranění, kdyby se sklopil. Sada obsahuje pouze šroubky pro upevnění držáků zabraňujících sklopení k výrobku. Ohledně správného typu vrutů/hmoždinek pro daný typ stěny se obraťte na vhodný obchod nebo železářství.

SK: VÝSTRAHA PRED PREVRÁTENÍM! Tento produkt musí byť natrvalo pripevnený k stene pomocou dodanej(-ých) konzoly (konzol), aby sa predišlo smrtelnému úrazu v prípade, že sa prevráti. Balenie obsahuje iba skrutky, ktorými sa pripevňujú k produktu samotné konzoly chrániace pred prevrátením. Kontaktujte miestnu predajňu pre domácich majstrov alebo železiarstvo, kde vám poradia ohľadom správneho typu skrutiek/príchytiiek pre váš typ steny.

DE: KIPPSICHERUNG Dieses Produkt muss ständig an der Wand mit der beigegeführten Klammer befestigt werden. Um geeigneten Dübel und Schrauben zu verwenden fragen Sie bitte einen Fachmann nach.

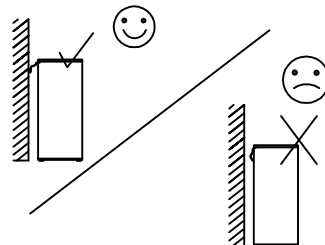
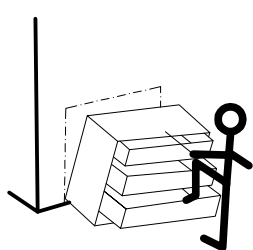
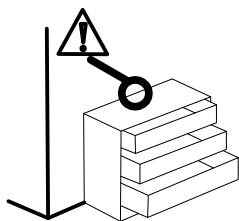

PL: OSTRZEŻENIE WS. USZKODZEŃ Aby uniknąć rys, ten mebel powinien być montowany, składany na miękkim podłożu, np. dywanie.

GB: WARNING TO AVOID SCRATCHES! In order to avoid scratching this furniture should be assembled on a soft layer - could be a rug.

FR: AVERTISSEMENT TYKAJICI SE POSKRABANI! Afin d'éviter les rayures, ce meuble doit être monté sur une surface souple (un tapis, par exemple).

CZ: VAROVANI TYKAJICI SE POSKRABANI! Aby nedošlo k poskrabaniu, sestavujte nabytok na mekkem podkladu - napr. na koberci.

SK: VÝSTRAHA TYKAJUCA SA PREDCHADZANIA SKRABANCOM! Aby sa predišlo skrabancom, tento nabytok by mal montovať na nakkom podklade, napríklad na koberci.

DE: WARNUNG GEGEN BESCHÄDIGUNGEN Um die Kratzer zu beseitigen, legen Sie bitte die Elemente auf einem weichen Boden, z.B. Teppich.

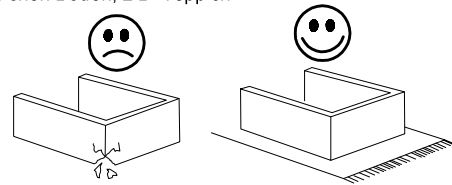

PL: OGÓLNE INSTRUKCJE DOTYCZĄCE MEBLI Z DREWNA ORAZ MATERIAŁÓW DREWNOPOCHODNYCH: MELAMINA, LAMINAT, OKLEINA Do czyszczenia należy używać wilgotnej ściereczki. Używać wyłącznie wody lub delikatnego detergentu. Wycierać do sucha ściereczką.

GB: GENERAL INSTRUCTION FOR FURNITURE MADE OF WOOD OR WOOD COMPOSITES SUCH AS MELAMINE, LAMINATE OR VENEER SURFACES Wipe clean with a damp cloth. Use only water or a gentle detergent. Wipe dry with a clean cloth.

FR: INSTRUCTIONS GÉNÉRALES POUR LE MOBILIER CONSTITUÉ DE BOIS OU DE COMPOSITES DE BOIS (COMME LES SURFACES EN MELAMINÉ, STRATIFIÉ OU PLACAGE) Nettoyer à l'aide d'un chiffon humide. Utiliser uniquement de l'eau ou un détergent doux. Essuyer à l'aide d'un chiffon propre.

CZ: OBECNÉ POKYNY TYKAJÍCÍ SE NÁBYTKU VYROBENÉHO ZE DŘEVA NEBO Z KOMPOZITŮ DŘEVA, NAPŘ. S POVRCHEM Z MELAMINU, LAMINÁTU NEBO DÝHY! Čistíte otřením navlhčeným hadříkem. Používejte pouze vodu nebo jemný čistící prostředek. Vytřete dosucha čistým hadříkem.

SK: VŠEOBECNÉ POKYNY PRE NÁBYTOK VYROBENÝ Z DREVA ALEBO KOMPOZITNÝCH MATERIÁLOV, NAPRIKLAD MELAMINU, LAMINÁTU ALEBO PREGLEJKOVÝCH POVRCHOV! Utrite dočista navlhčenou utierkou. Používajte iba vodu alebo jemný čistiaci prostriedok. Utrite dosucha čistou utierkou.

DE: ALLGEMEINE ANWEISUNGEN FÜR REINIGUNG DES HOLZES UND HÖLZÄHNLICHEN PRODUKTEN: MELAMIN, LAMINAT, BESCHICHTUNG Zur Möbelreinigung verwenden Sie ein mit Wasser oder Feinwaschmittel befeuchtetes, Baumwolltuch. Gereinigte Flächen immer trockenreiben!

PL: WAŻNE! Ważne jest, żeby każdy ze skręcanych produktów został ponownie dokręcony w ciągu 2 tygodni od montażu, a następnie sprawdzać co 3 miesiące czy śruby są dokręcone – w celu zapewnienia stabilności przez czas użytkowania produktu.

GB: IMPORTANT! It is important that any product which is assembled using any kind of screw is re-tightened 2 weeks after assembly, and once every 3 months - in order to assure stability through-out the lifespan of the product.

FR: IMPORTANT Il est important que tout produit monté à l'aide de vis soit resserré 2 semaines après son montage, puis tous les 3 mois, afin de garantir sa stabilité durant tout son cycle de vie.

CZ: DŮLEŽITÉ! U každého výrobku, který se sestavuje pomocí jakýchkoli šroubků, je důležité dotáhnout šroubky 2 týdny po sestavení a potom každé 3 měsíce, aby byla zajištěna stabilita po celou dobu životnosti výrobku.

SK: DÔLEŽITÉ! Je dôležité, aby sa na akomkoľvek produkte, montovanom pomocou akýchkoľvek skrutiek, skrutky dotiahli po dvoch týždňoch od montáže, a jedenkrát v priebehu každých 3 mesiacov - tak sa zaručí stabilita počas celej životnosti produktu.

DE: WICHTIG! Es ist sehr wichtig ca. 2 Wochen nach der Montage alle Befestigungen zu überprüfen und dieses Vorgehen jede 3 Monate zu wiederholen, um Lebensdauer des Möbels zu verlängern.

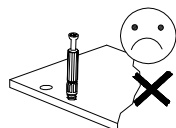
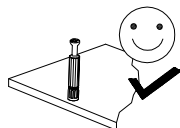

# 1.



Ax14



Gx4



S2x2



S1x2



Wx8

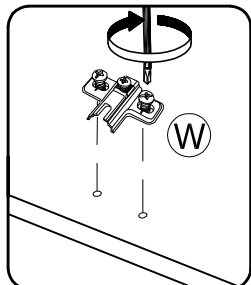
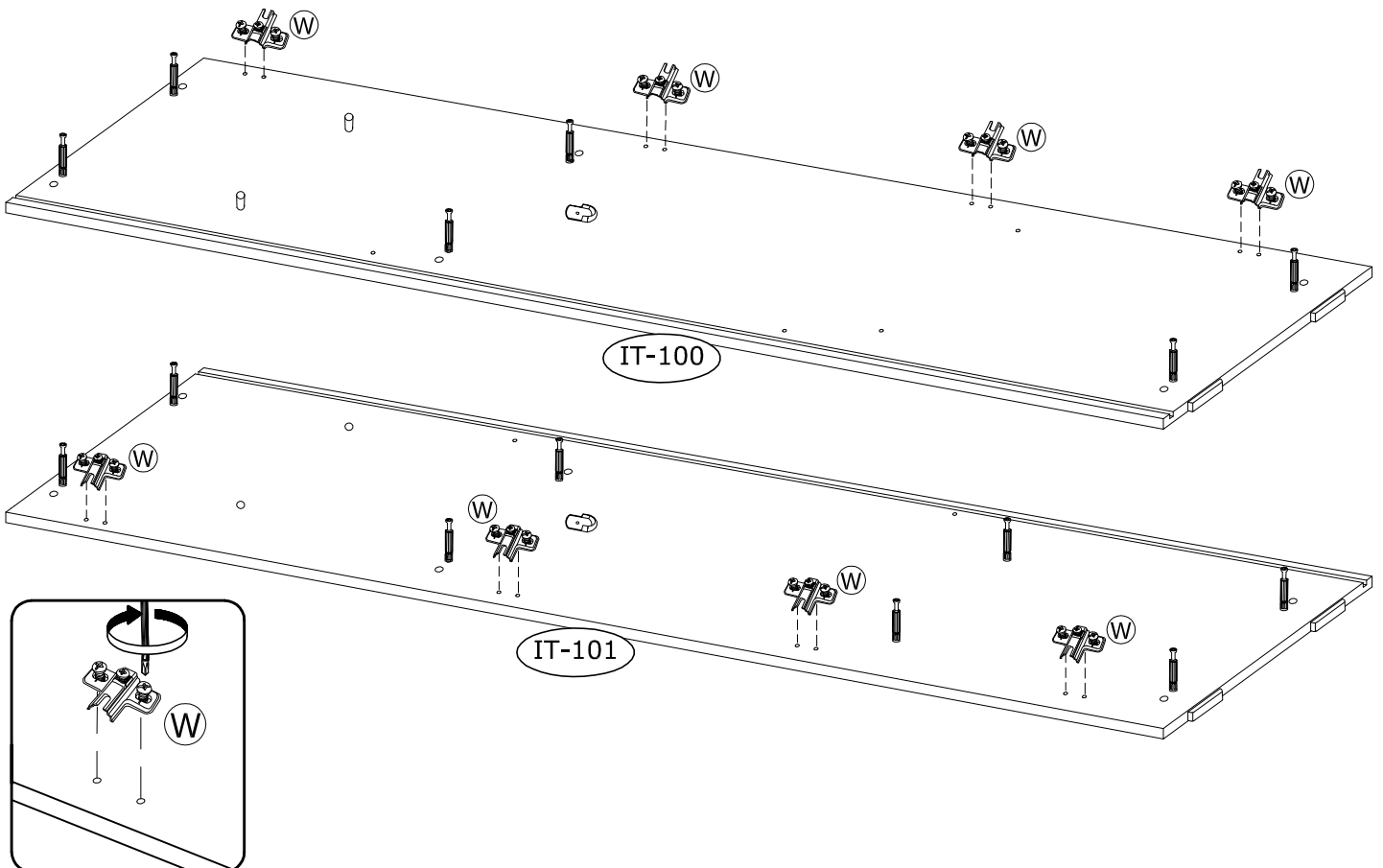
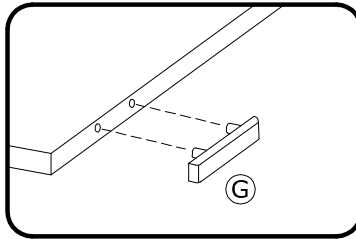
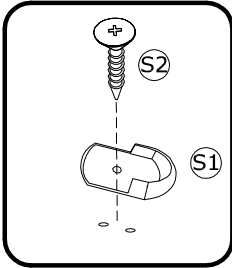
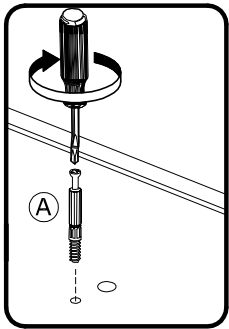
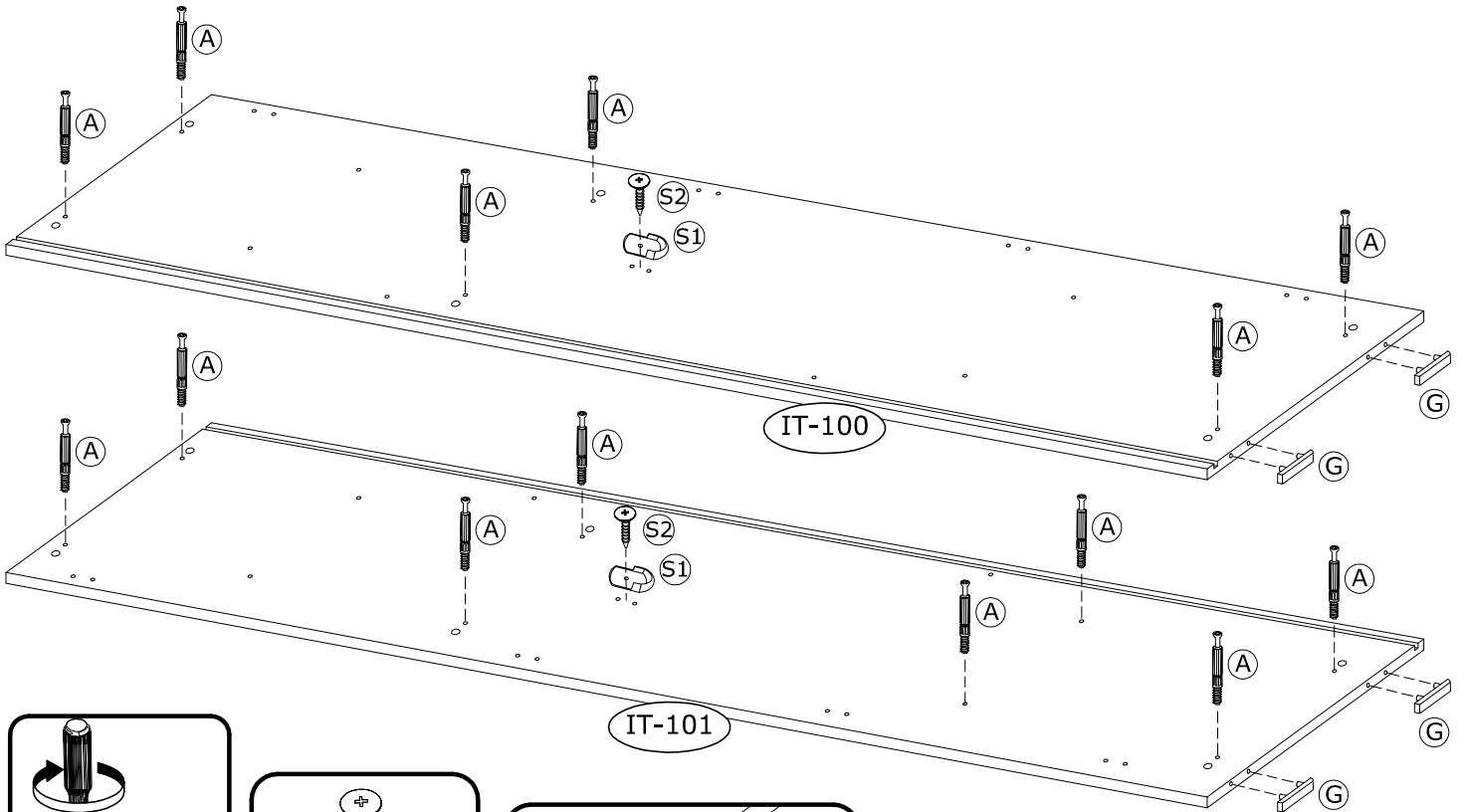

# 2.

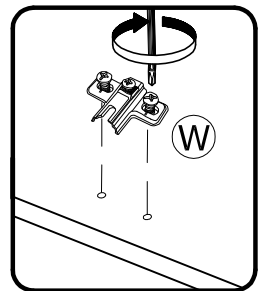
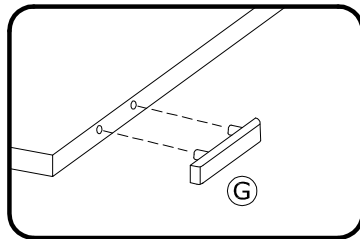
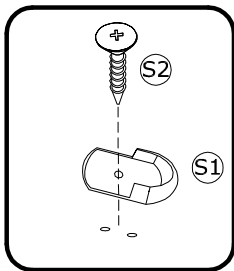
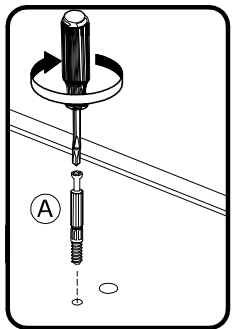
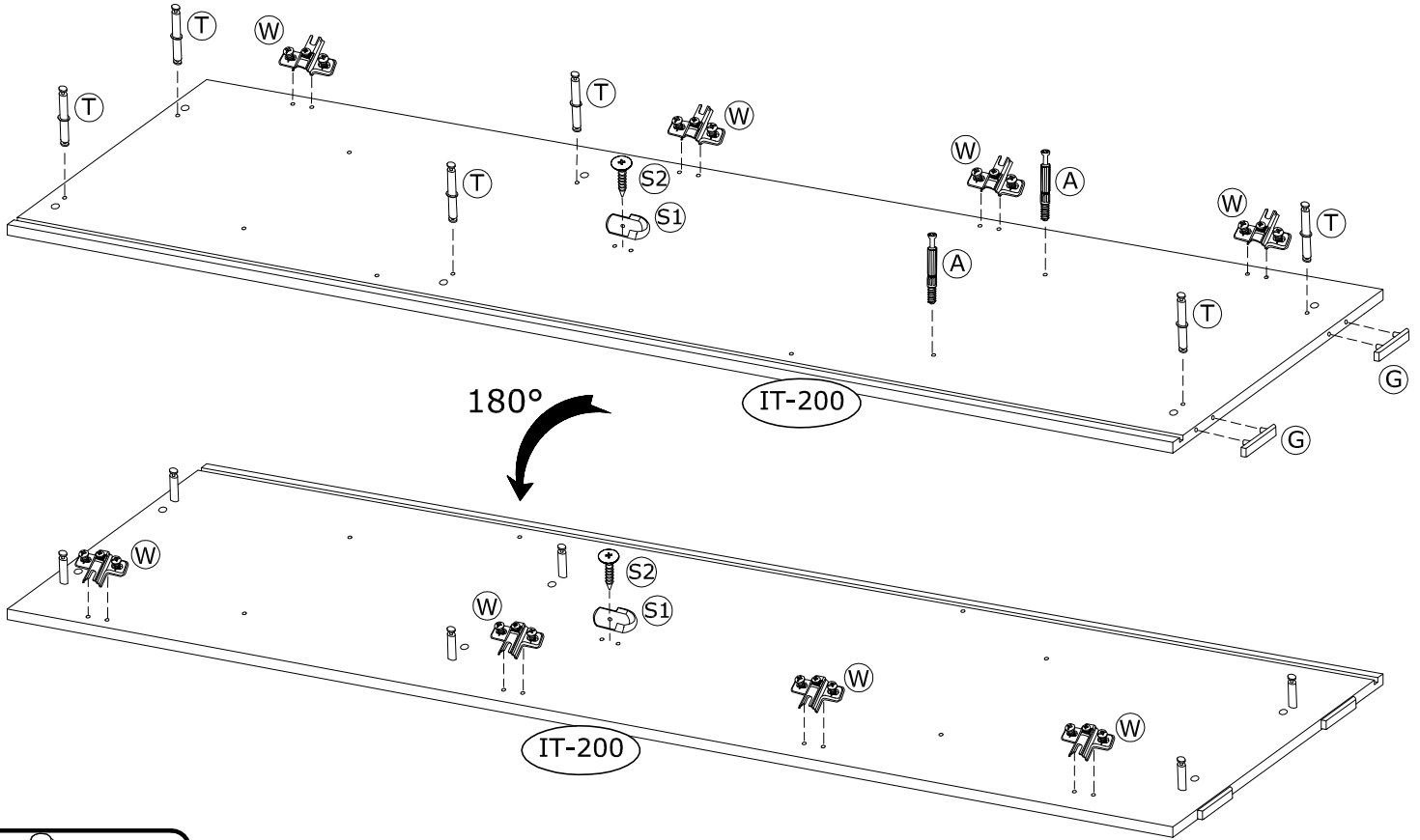
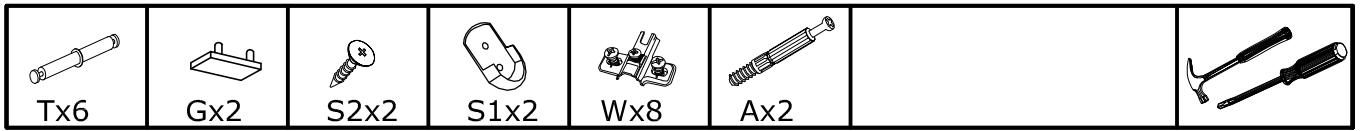

# 3.

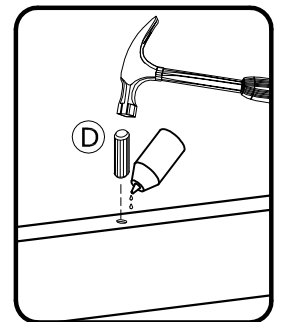
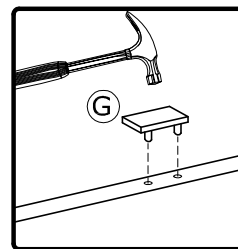
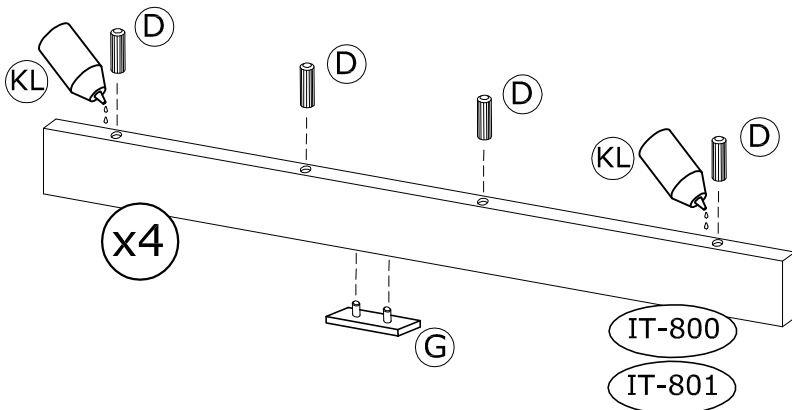

# 4.

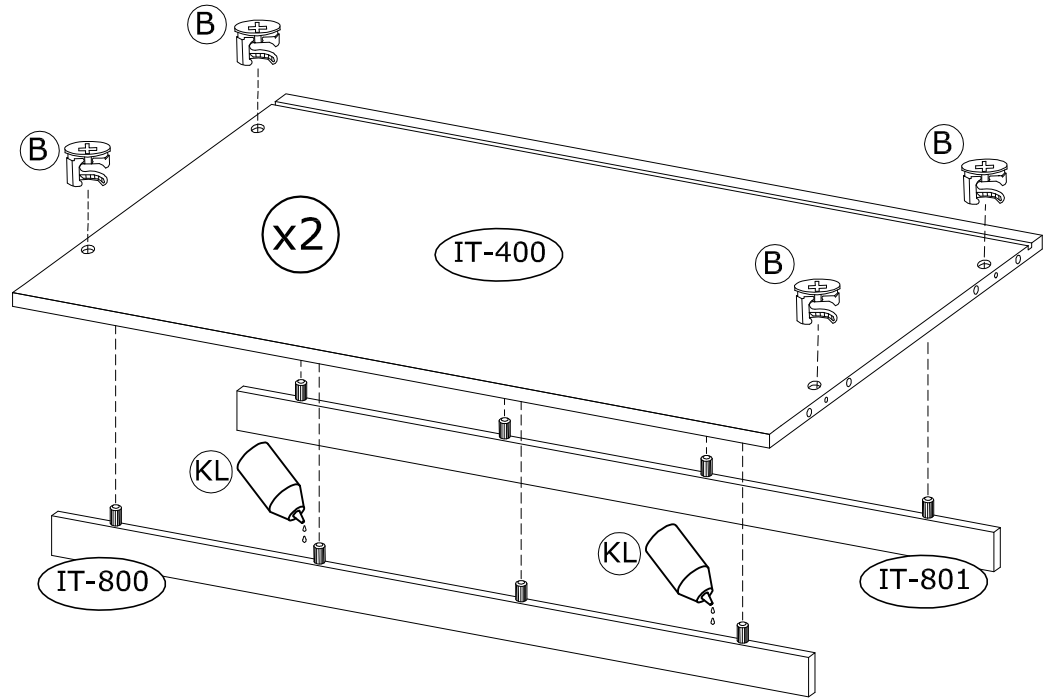
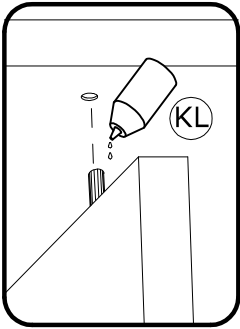
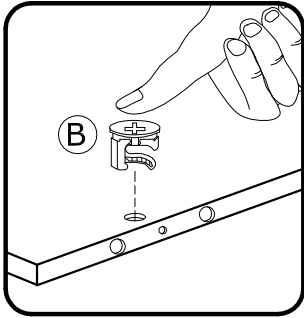

# 5.

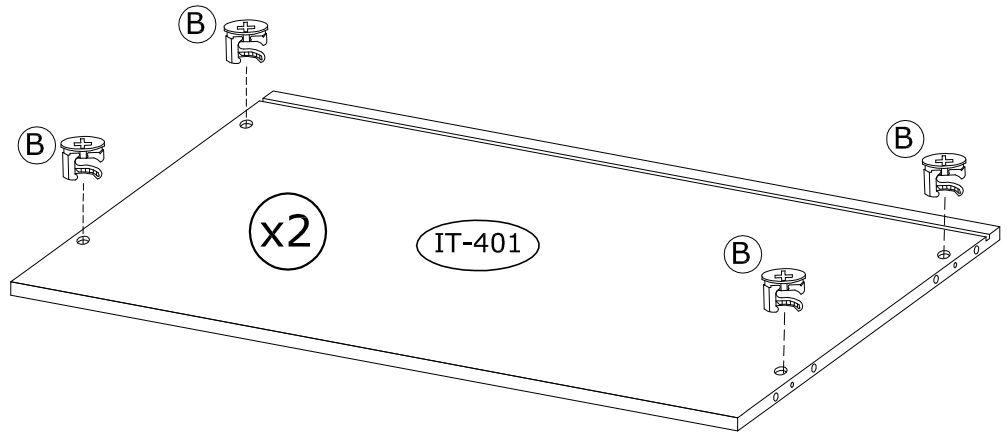
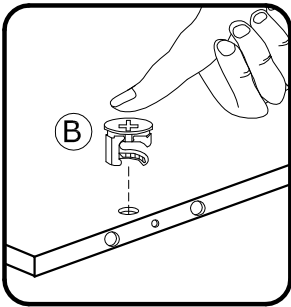

# 6.

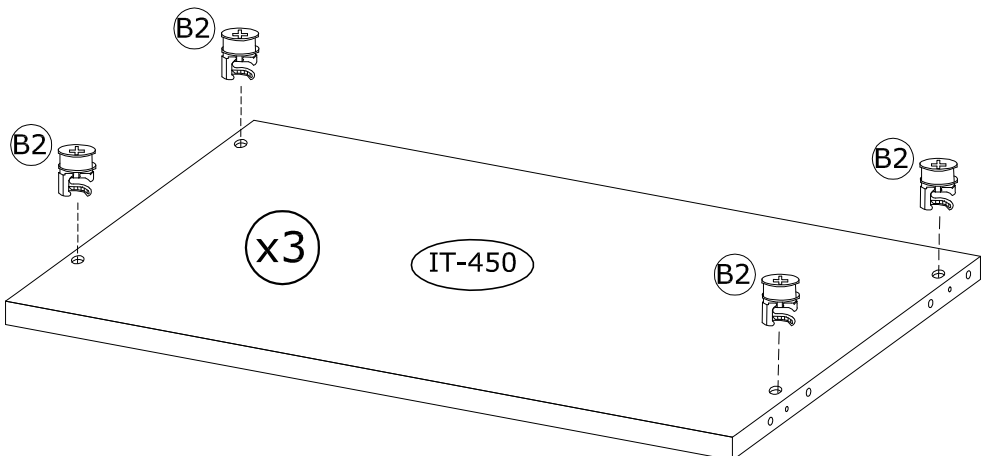
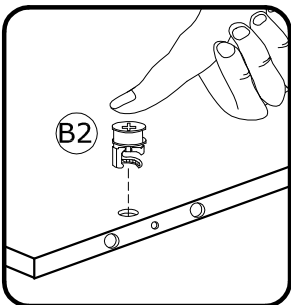

# 7.

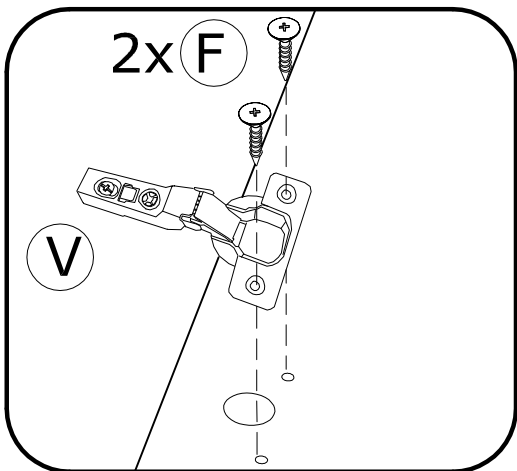
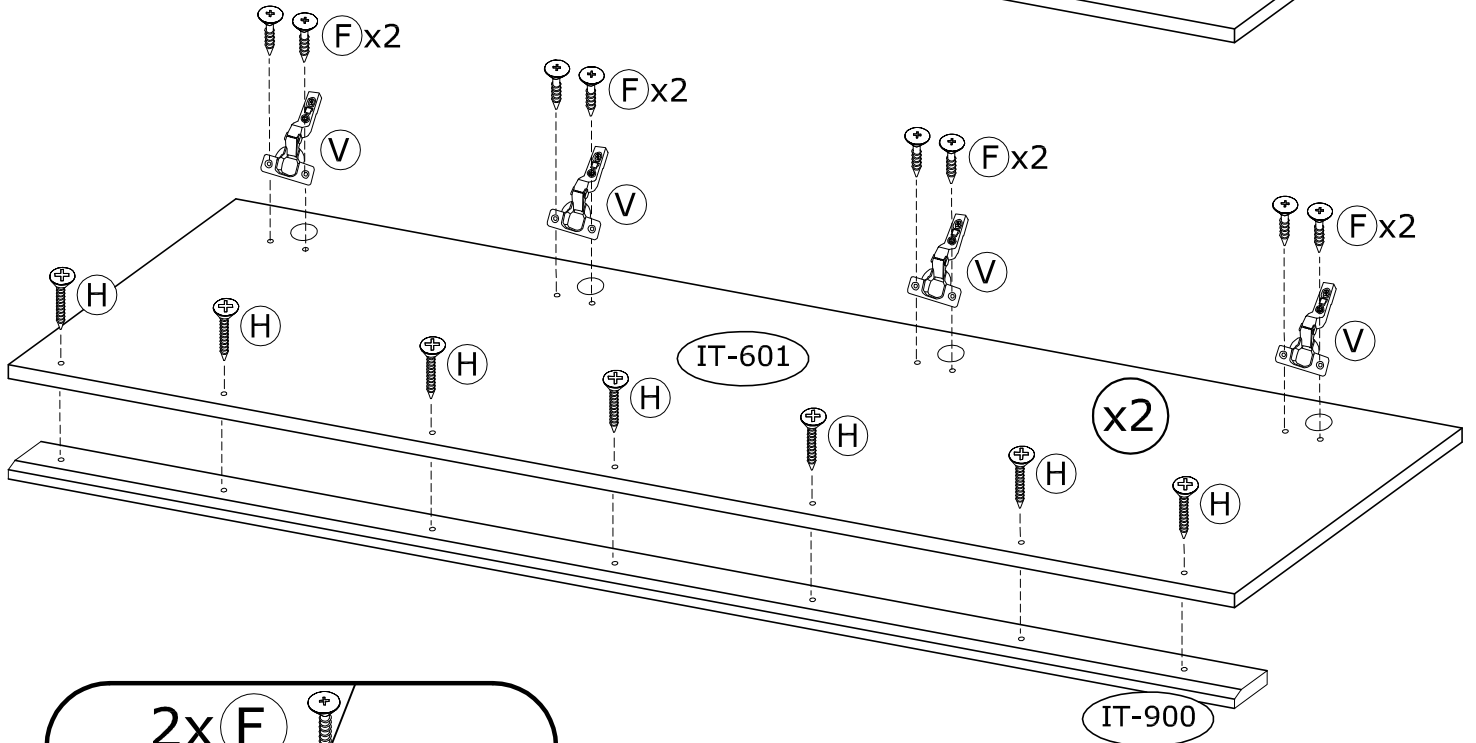
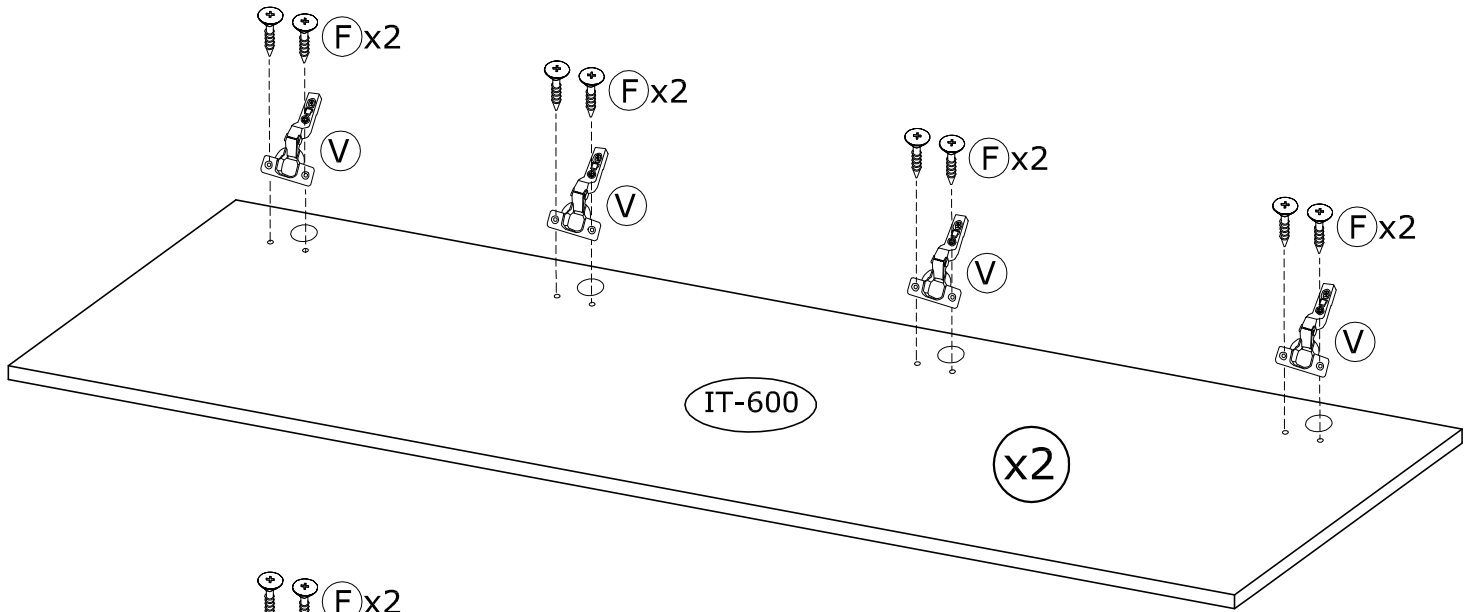



# 8.



Dx12



Qx1

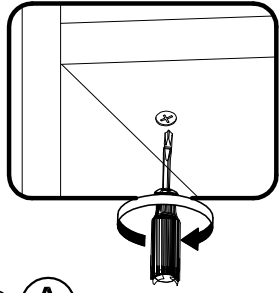
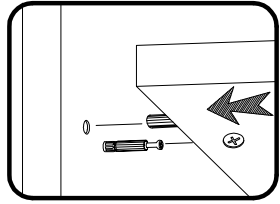
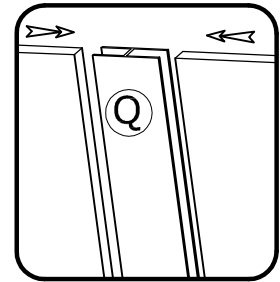
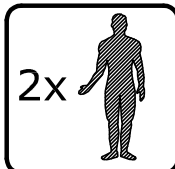
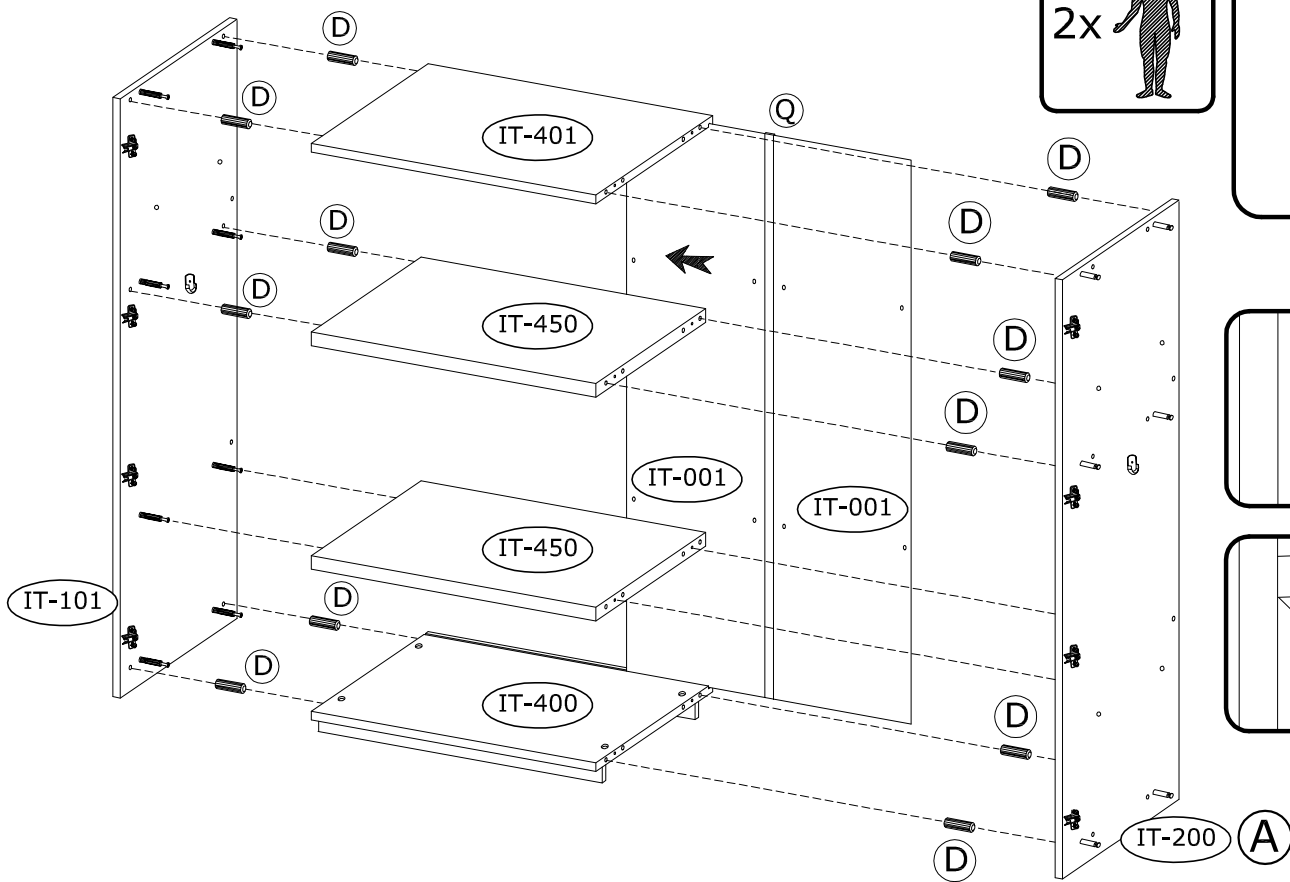

# 9.



Dx12



Qx1

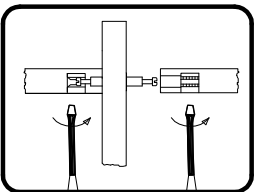
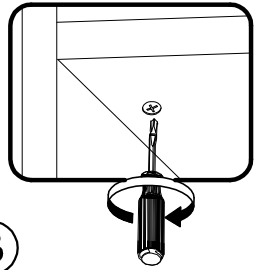
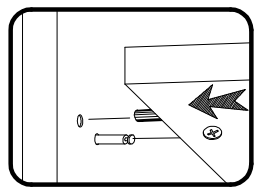
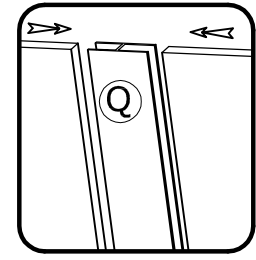
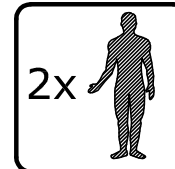
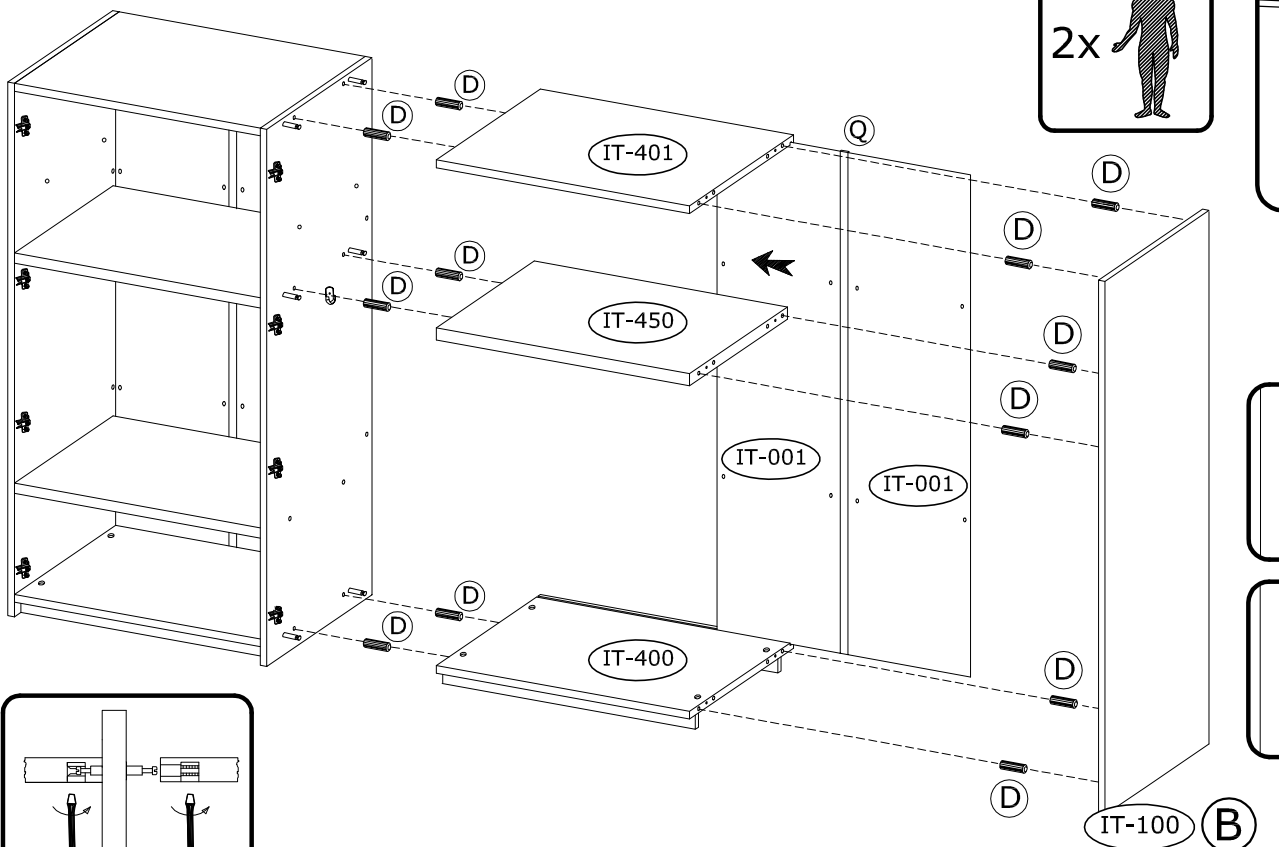

**B**

# 10.



Mx8



Nx8

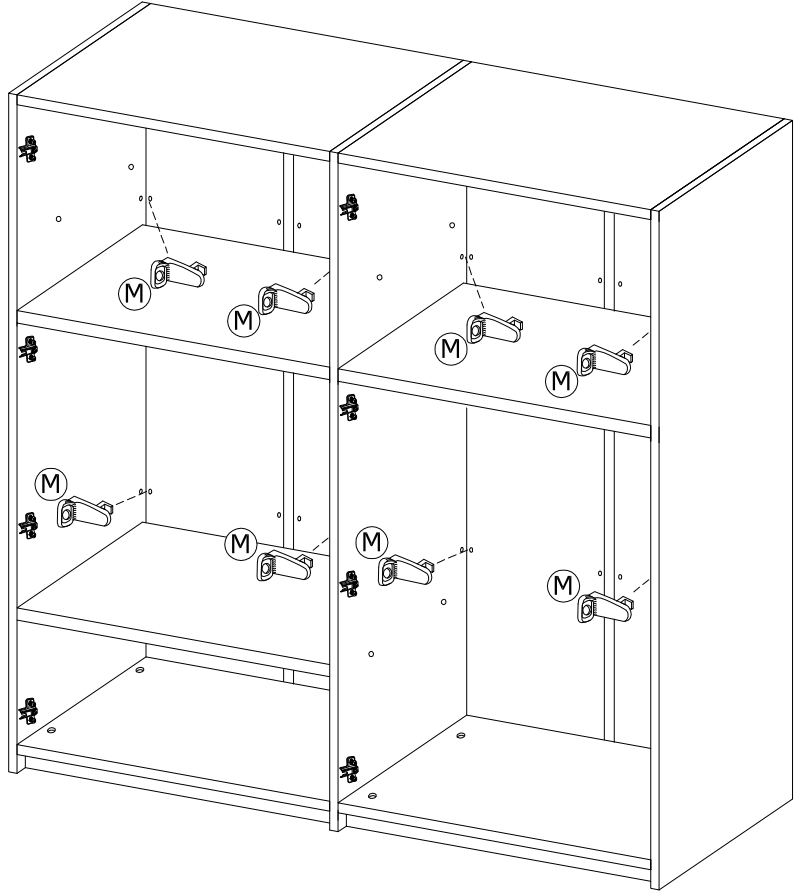
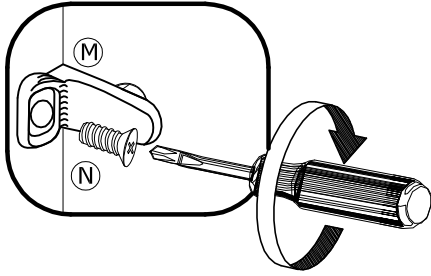
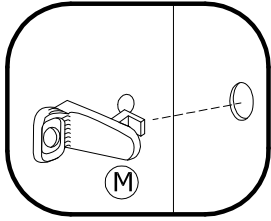

# 11.



Jx30

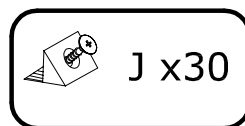
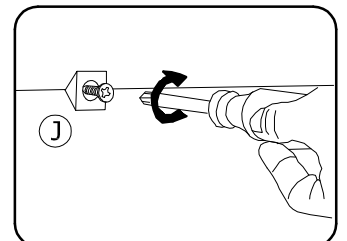
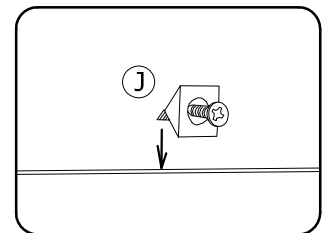
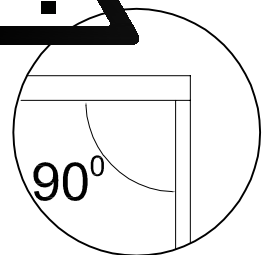
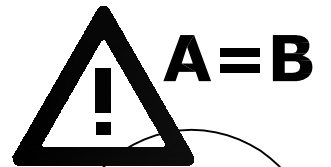
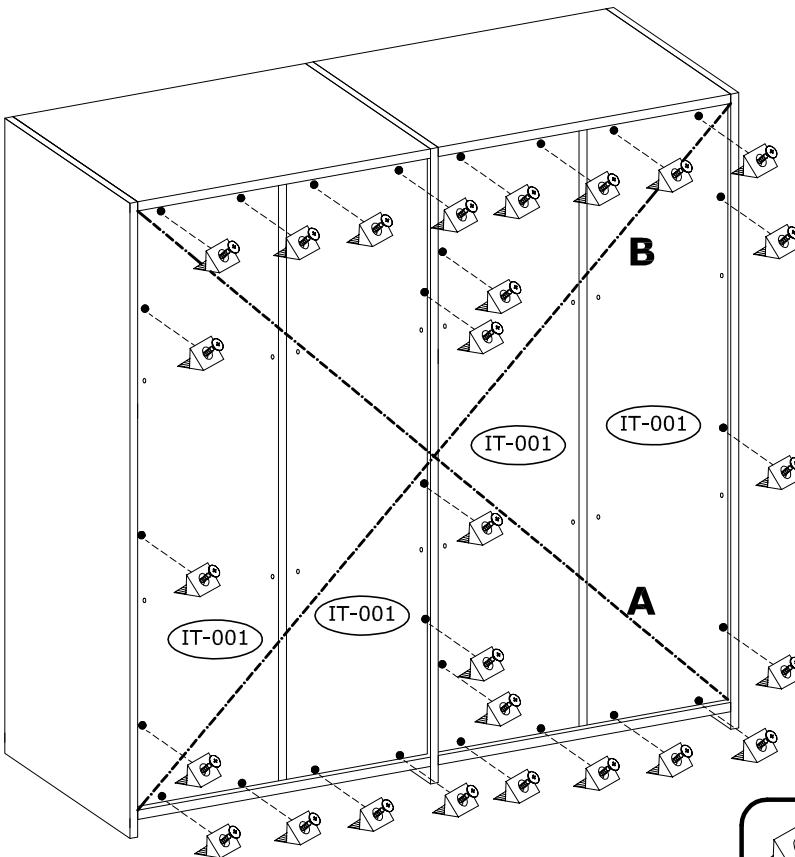

# 12.

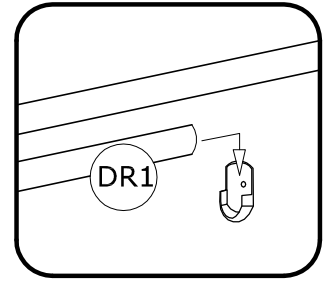
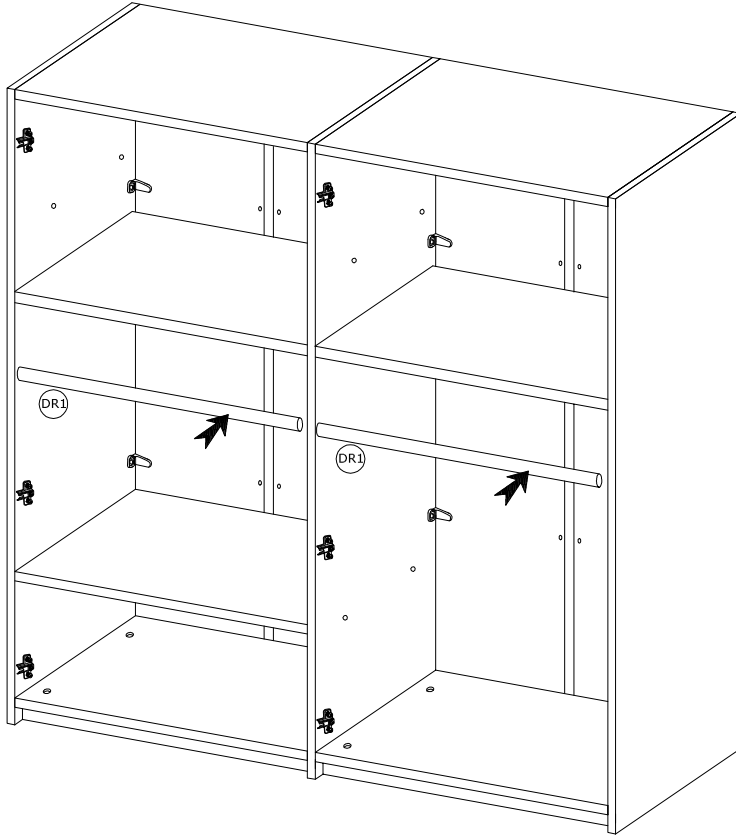
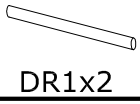

# 13.

